

TCF-142-RM Series

Hardware Installation Guide

Second Edition, May 2010



© 2010 Moxa Inc. All rights reserved.
Reproduction without permission is prohibited.

F1.4, No.135, Lane 235, Pao-Chiao Rd. Shing Tien City, Taipei, Taiwan,
R.O.C.

TEL: +886-2-8919-1230

P/N: 1802001420621

Overview

Introduction

The TCF-142-RM series fiber converters are slide-in modules that can be installed in the NRack System's rackmount chassis, such as the TRC-190 series. The slide-in module is equipped with a multiple interface circuit that can handle RS-232 or RS-422/485 serial interfaces, and multi-mode or single-mode fiber. The TCF-142-RM series slide-in modules are used to extend serial transmission distance up to 5 km (TCF-142-M-XX-RM, with multi-mode fiber) or up to 40 km (TCF-142-S-XX-RM, with single-mode fiber).

Why Convert Serial to Fiber?

Fiber communication not only extends the communication distance, but also provides many advantageous features. **IMMUNITY FROM ELECTRICAL INTERFERENCE:** Fiber is not affected by electromagnetic interference or radio frequency interference. It provides a clean communication path and is immune to cross-talk. **INSULATION:** Optical fiber is an insulator; the glass fiber eliminates the need for using electric currents as the communication medium. **SECURITY:** Fiber cannot be tapped by conventional electric means and is very difficult to tap into optically. Furthermore, radio and satellite communication signals can be captured easily for decoding. **RELIABILITY & MAINTENANCE:** Fiber is immune to adverse temperature and moisture conditions, does not corrode or lose its signal, and is not affected by short circuits, power surges, or static electricity.

No Configuration Required for Baudrate Settings

The TCF-142-RM slide-in modules work under any baudrate from 50 bps to 921.6 Kbps. The TCF-142-RM slide-in modules simply convert the signal back and forth between serial (RS-232, RS-422, or RS-485) and fiber, and since the TCF-142-RM slide-in modules do not need to interpret the signal, it does not need to know the baudrate of the transmitting device. For this reason, the TCF-142-RM slide-in modules do not have any DIP switches or jumpers for setting the baudrate.

Ring Mode

To allow one half-duplex serial device to communicate with multiple half-duplex devices connected to a fiber ring, you should configure the TCF-142-RM slide-in modules for "ring mode" by setting DIP switch "SW3" to the "On" position. The Tx port of a particular TCF-142-RM slide-in modules unit connects to the neighboring converter's Rx port to form the ring. Note that when one node transmits a signal, the signal travels around the ring until it returns to the transmitting unit, which then blocks the signal. Users should ensure that the total fiber ring length is less than 100 km when using either single-mode models or multi-mode models.

Installation

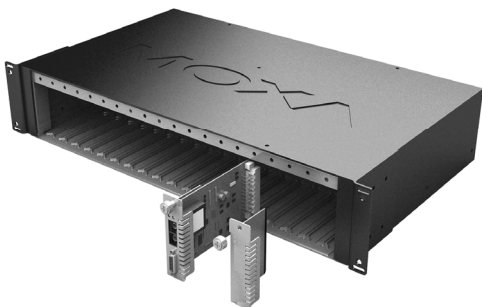

The media converter slide-in module can be hot-swapped, which means the chassis doesn't have to power off or be removed during installation. Align the slide-in module with the chassis installation slot so that the panel fastener screw is at the top of the module. Carefully slide the slide-in module into the slot while aligning the module's circuit board with the installation guide. Ensure the slide-in module is firmly seated inside the chassis. Push in and rotate the attached panel fastener screw clockwise to secure the module to the chassis.

Features

- “Ring” or “Point to Point” transmission
- Extend RS-232/422/485 transmission distance:
 - up to 40 km with single-mode—TCF-142-S-XX-RM slide-in modules series
 - up to 5 km with multi-mode—TCF-142-M-XX-RM slide-in modules series
- Slide-in modules of NRack system
- Decrease signal interference
- Protect against electrical degradation and chemical corrosion
- Support baudrate up to 921.6 Kbps

Package Checklist

Before installing the TCF-142-RM slide-in module, verify that the package contains the following items:

- TCF-142-RM slide-in module Fiber Converter
- Quick Installation Guide
- Warranty Card

NOTE: Please notify your sales representative if any of the above items are missing or damaged.

Mounting Dimensions (Unit : mm)

TCF-142-SC

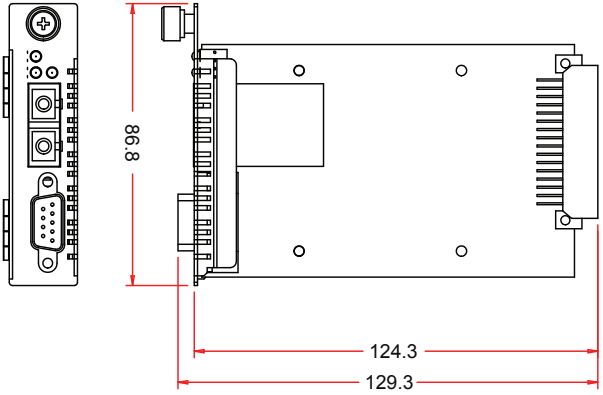

TCF-142-ST

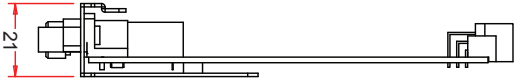
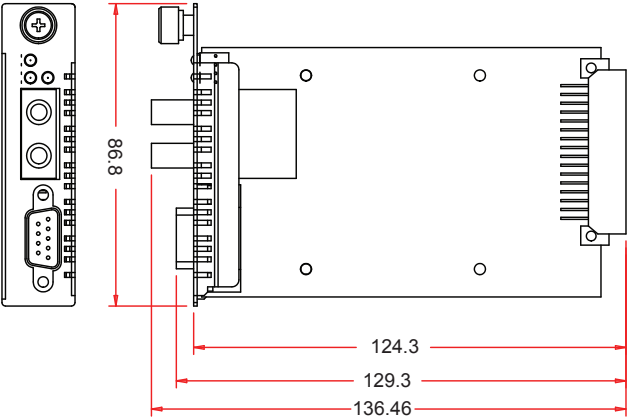

ATTENTION Electrostatic Discharge Warning!



To protect the product from damage due to electrostatic discharge, we recommend wearing a grounding device when handling your TCF-142-RM-slide-in modules module series.

Pin Assignment and Connector

9-pin D-sub Female

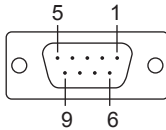

Pin	RS-232	RS-422/485-4w	RS-485-2W
1	DCD	RxD-(A)	Data-(A)
2	TxD	RxD+(B)	Data+(B)
3	RxD	TxD+(B)	-
4	DSR	TxD-(A)	-
5	GND	GND	GND
6	DTR	-	-
7	CTS	-	-
8	RTS	-	-
9	-	-	-

Fiber Cable

SC-Port Pinouts

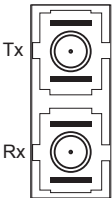

SC-Port to SC-Port Cable Wiring



Cable Wiring

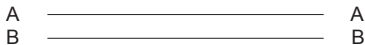

ST-Port Pinouts

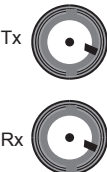

ST-Port to ST-Port Cable Wiring



Cable Wiring



ATTENTION

This is a Class 1 Laser/LED product. Do not stare into the Laser Beam.



Switch Settings

There are 2 sets of DIP switches on the board. One set for fiber and another for the connector. Following are the settings for the 4 connector DIP switches.

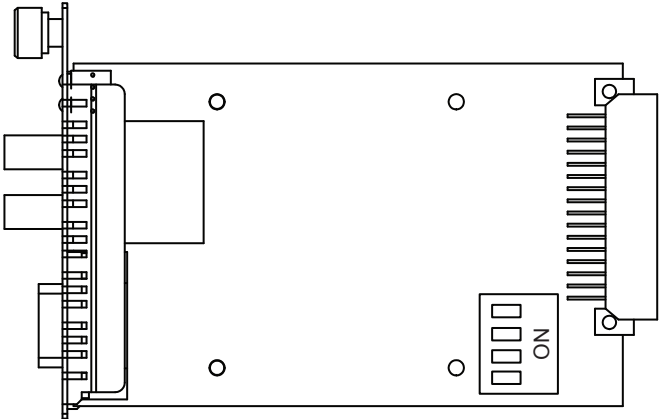

Serial Connection	Switch 1	Switch 2
RS-232	ON (default)	ON (default)
RS-422	ON	OFF
2-wire RS-485	OFF	ON
4-wire RS-485	OFF	OFF

120Ω Terminator	Switch 3
Enable	ON
Disable	OFF (default)

Fiber Mode	Switch 4
Ring Mode	ON
Point to Point Mode	OFF (default)

ATTENTION For Fiber Ring Users:

Before you plug the slide-in module into the chassis, make sure the DIP switch settings are correct before inserting the slide-in module into the chassis and connecting the serial and fiber cables. If the Rx LEDs of the converter glow continuously, remove the fiber cable and reconnect.

NOTE: “Ring Mode” can only be used for half-duplex applications.

Following are the settings for the 2 fiber DIP switches.

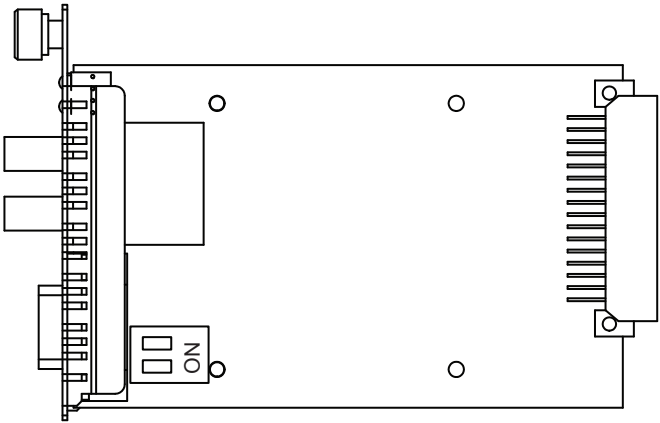

	Switch 1 (Pull Low)	Switch 2 (Pull High)
150K Ω	OFF	OFF
1K Ω	ON (Default)	ON (Default)

LED Indicators

There are 3 LEDs on the front bracket of the TCF-142-RM slide-in modules.

LED	Color	Function
PWR	Green	Steady ON: Power is ON
Fiber Tx	Green	When sending serial data from the fiber port
Fiber Rx	Yellow	When receiving data from the fiber port

Specifications

Serial Communication

Signals for RS-232	TxD, RxD, SGND
Signals for RS-422	TxD+, TxD-, RxD+, RxD-, SGND
Signals for 4-wire RS-485	TxD+, TxD-, RxD+, RxD-, SGND
Signals for 2-wire RS-485	Data+, Data-, SGND
Baudrate	50 bps to 921.6 Kbps
ESD protection	15 KV ESD

Fiber Communication

Connector type	ST or SC
Distance	Single mode fiber for 40 km Multi mode fiber for 5 km
Support Cable :	8.3/125, 8.7/125, 9/125 or 10/125 μm (single mode) 50/125, 62.5/125, or 100/140 μm (multimode)
Wavelength	Single mode: 1310 nm Multimode: 850 nm
TX Output	Single mode: > -5 dBm Multimode: > -5 dBm
RX Sensitivity	Single mode: -25 dBm Multimode: -20 dBm
Point-to-Point Transmission	Half or Full duplex
Multi-drop Transmission	Half duplex, fiber ring

Environmental

Operating Temperature	0 to 60°C (32 to 142°F), 5 to 95 % RH
Storage Temperature	-20 to 75°C (-4 to 185°F), 5 to 95 % RH

Power

Input Power Voltage	12 VDC
Power Consumption	150 mA @ 12V

Mechanical

Dimensions (W \times D \times H)	86.8 \times 136.46 \times 21mm
Material	SPCC
Gross Weight	80g

Regulatory Approvals

CE	Class B
FCC	Part 15 sub part B Class A
EMS	EN61000-4-2 (ESD), Criteria B, Level 4 EN61000-4-3 (RS), Criteria A, Level 2 EN61000-4-4 (EFT), Criteria B, Level 3 EN61000-4-5 (Surge), Criteria A, Level 3 EN61000-4-6 (CS), Criteria A, Level 2 En61000-4-8(PFMF), Criteria A, Level 3
Free fall	IEC 60068-2-32

Technical Support Contact Information

www.moxa.com/support

Moxa Americas:

Toll-free: 1-888-669-2872

Tel: +1-714-528-6777

Fax: +1-714-528-6778

Moxa China (Shanghai office):

Toll-free: 800-820-5036

Tel: +86-21-5258-9955

Fax: +86-21-5258-5505

Moxa Europe:

Tel: +49-89-3 70 03 99-0

Fax: +49-89-3 70 03 99-99

Moxa Asia-Pacific:

Tel: +886-2-8919-1230

Fax: +886-2-8919-1231